

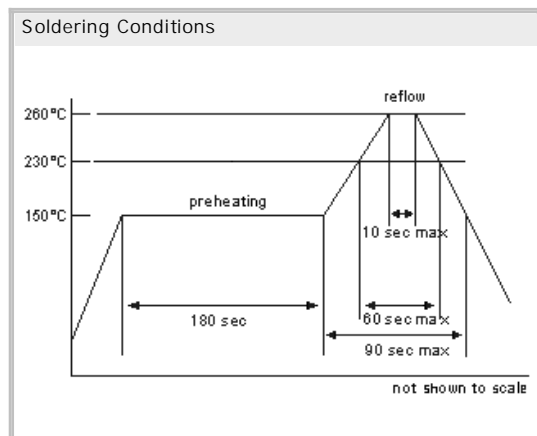

Quartz Crystal Unit TC-26

- kHz Range Crystal Unit
- Cylinder Metal Case (6.0 x 2.0) mm
- Available in many standard and special frequencies
- Applications for Clock and Microcomputer
- RoHS conform; Lead-free product

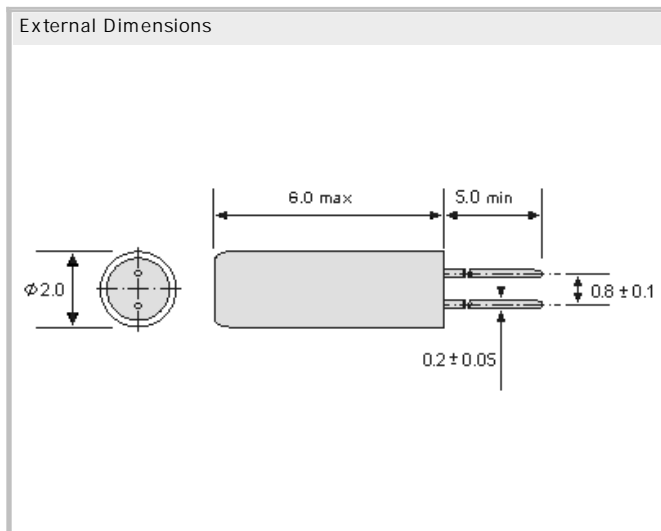

Specifications - Product No. A000153600AMFAPN43EE

Holder Type:	TC-26
Frequency:	153.600000 kHz
Frequency Stability at 25°C:	± 20 ppm
Temperature Stability:	± 20 ppm @ -40°C to +85°C
Storage Temperature:	-40°C to +85°C
Drive Level:	1.0 µW max.
Load Capacitance (CL):	12.5 pF
Shunt Capacitance (CO):	< 2pF
Equivalent Series Resistance:	40 kOhm max.
Aging:	< ± 5 ppm max./year

GERMANY:

COMTEC CRYSTALS GmbH · Sultenstrasse 12-14
 8 5 5 8 6 P o i n g / G E R M A N Y
 Phone +49 8121 778160 · Fax +49 8121 778177
 e-Mail info@comtec-crystals.com
 Internet: <http://www.comtec-crystals.com>
 Subject to change without prior notice.



Technical Data and Graphics are all under
 Copyright (c) of Comtec Crystals Group.

FRANCE:

COMTEC CRYSTALS SARL · 23, rue du Faucon
 6 7 5 0 0 H a g u e n a u / F R A N C E
 Phone +33 388 732162 · Fax +33 388 730118
 e-Mail sales@comtec-crystals.com
 Internet: <http://www.comtec-crystals.com>
 Sous réserve de modifications.