

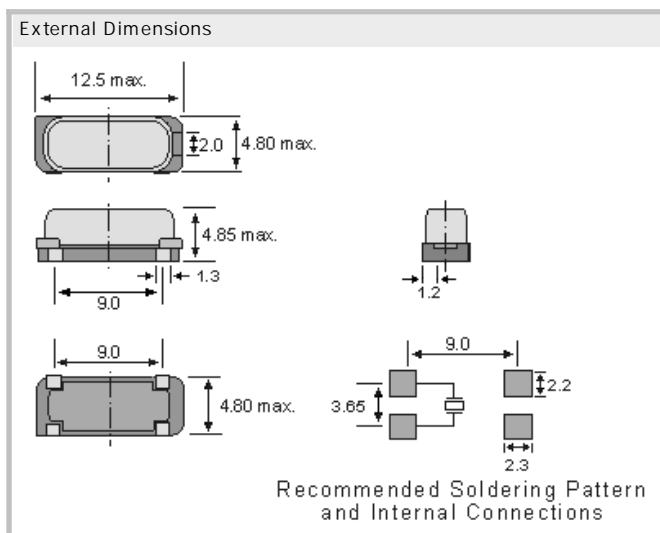

Quartz Crystal Unit HC49SM4 (with 4 pads)  
h ~ 4.85mm

- Standard Quartz Crystal SMD with 4 pads
- Metal Case
- on Tape & Reel
- RoHS conform; Lead-free product
- Available in many standard and special frequencies



## Specifications - Product No. A01000000BDFEPN43DB

Holder Type:	HC-49SM4 with 4 pads
Frequency:	10.000000 MHz
Frequency Stability at 25°C:	± 30 ppm
Temperature Stability:	± 50ppm @ -40°C to +85°C
Storage Temperature:	-50°C to +105°C
Drive Level:	100µW (500µW max.)
Load Capacitance (CL):	30 pF
Shunt Capacitance (CO):	< 7pF
Crystal Cut & Vibration Mode:	AT- cut, fundamental
Equivalent Series Resistance:	50 Ohm max.
Aging:	< ± 3ppm max. / year (max.)

### GERMANY:

COMTEC CRYSTALS GmbH · Sultenstrasse 12-14  
8 5 5 8 6 P o i n g / G E R M A N Y  
Phone +49 8121 778160 · Fax +49 8121 778177  
e-Mail [info@comtec-crystals.com](mailto:info@comtec-crystals.com)  
Internet: <http://www.comtec-crystals.com>  
Subject to change without prior notice.



Technical Data and Graphics are all under  
Copyright (c) of Comtec Crystals Group.

### FRANCE:

COMTEC CRYSTALS SARL · 23, rue du Faucon  
6 7 5 0 0 H a g u e n a u / F R A N C E  
Phone +33 388 732162 · Fax +33 388 730118  
e-Mail [sales@comtec-crystals.com](mailto:sales@comtec-crystals.com)  
Internet: <http://www.comtec-crystals.com>  
Sous réserve de modifications.