

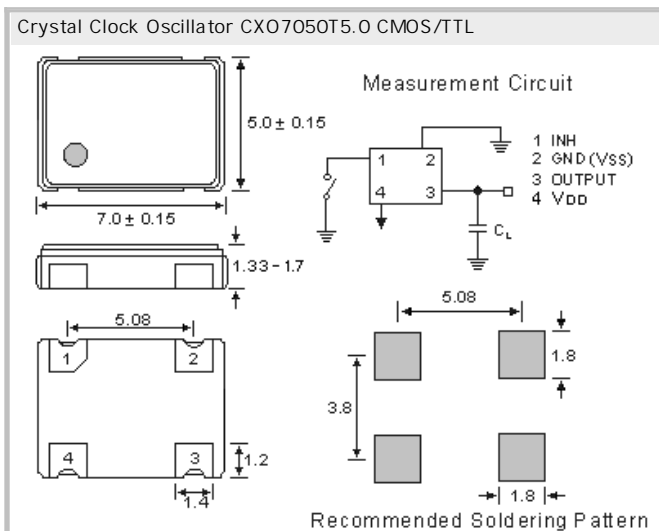

Crystal Clock Oscillator CXO7050T5.0
5.0V CMOS/TTL, Low cost

- SMD in ceramic case (7.0 x 5.0 x 1.7) mm
- Tri-State Enable / Disable
- CMOS/TTL Square Wave
- on Tape & Reel (Tape 16mm)
- RoHS conform; Lead-free product
- Vibration: MIL-STD-202F method 204, 35G, 50 to 2000 Hz
- Shock: MIL-STD-202F method 213B, test cond. E, 1000GG 1/2 sine wave
- Available in many standard and special frequencies



Specifications

| | |
|----------------------------------|---|
| Holder Type: | Crystal Clock Oscillator CXO7050T5.0 5.0V CMOS/TTL |
| Frequency: | 1.843200 MHz |
| Frequency Stability at 25°C: | ± 50.0 ppm |
| Operating Temperature Range: | ± 50.0 ppm over -40°C to +85°C (inclusive of 25°C tolerance, ±10% input voltage variation, load change, aging, shock and vibration) |
| Storage Temperature: | -50°C to +105°C |
| Power Supply Voltage (Vdd): | + 5.0V D.C. ± 10% |
| Maximum Supply Current: | 10.0mA max. |
| Output Load: | 15 pF CMOS / 10LS TTL gates max. |
| Output Symmetry (Duty Cycle): | 40/60% |
| Output Voltage (VOH) (VOL): | 90% of Vdd min. / 10% of Vdd max. |
| Rise/Fall Time (10% to 90% Vdd): | 10 ns max. < 5 ns typical |
| Start Up Time: | 10 ms max. < 5 ms typical |
| Tri-state Function Pin 1: | Pin 1 = H or open... Output active at pin 3 Pin 1 = L... high impedance at pin 3 |
| Phase Jitter (12 kHz to 20 MHz): | < 1pS RMS |
| Aging: | < ± 5ppm max. / year (max.) |
| Reflow Condition: | 260°C max. for 10 sec. |

GERMANY:

COMTEC CRYSTALS GmbH · Sultenstrasse 12-14
8 5 5 8 6 P o i n g / G E R M A N Y
Phone +49 8121 778160 · Fax +49 8121 778177
e-Mail info@comtec-crystals.com
Internet: <http://www.comtec-crystals.com>
Subject to change without prior notice.



Technical Data and Graphics are all under
Copyright (c) of Comtec Crystals Group.

FRANCE:

COMTEC CRYSTALS SARL · 23, rue du Faucon
6 7 5 0 0 H a g u e n a u / F R A N C E
Phone +33 388 732162 · Fax +33 388 730118
e-Mail sales@comtec-crystals.com
Internet: <http://www.comtec-crystals.com>
Sous réserve de modifications.