

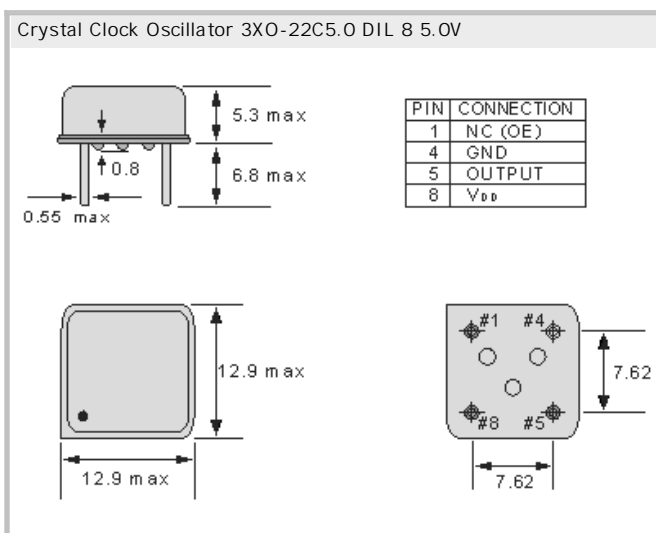

Crystal Clock Oscillator 3XO-22C5.0 DIL 8 5.0V

- micro-processor clocks
- ultra compact metal package
- CMOS/TTL Square Wave
- Available in many standard and special frequencies
- packed in antistatic tubes
- RoHS conform; Lead-free product



Specifications

Holder Type:	Crystal Clock Oscillator 3XO-22C5.0 DIL 8 5.0V
Frequency:	36.000000 MHz
Frequency Stability at 25°C:	± 100 ppm
Operating Temperature Range:	± 100 ppm over ±0°C to +70°C (inclusive of 25°C tolerance, ± 10% input voltage variation, load change, aging, shock and vibration)
Storage Temperature:	-50°C to +100°C
Power Supply Voltage (V _{DD}):	+ 5.0V D.C. ± 10%
Maximum Supply Current:	15.0 mA
Output Load CL:	2 - 10 (LS) TTL gates, 15 pF HCMOS
Output Symmetry (Duty Cycle):	40/60%
Output Voltage (V _{OH}) (V _{OL}):	90% of V _{DD} min. / 10% of V _{DD} max.
Rise/Fall Time (10% to 90% V _{DD}):	10 ns max. < 5 ns typical
Start Up Time:	10 ms max. < 5 ms typical
Moisture sensitivity level:	MSL= 1 per IPC/JEDEC J-STD-020 C
Aging:	< ± 5ppm max. / year (max.)

GERMANY:

COMTEC CRYSTALS GmbH · Sultenstrasse 12-14
8 5 5 8 6 P o i n g / G E R M A N Y
Phone +49 8121 778160 · Fax +49 8121 778177
e-Mail info@comtec-crystals.com
Internet: <http://www.comtec-crystals.com>
Subject to change without prior notice.



Technical Data and Graphics are all under
Copyright (c) of Comtec Crystals Group.

FRANCE:

COMTEC CRYSTALS SARL · 23, rue du Faucon
6 7 5 0 0 H a g u e n a u / F R A N C E
Phone +33 388 732162 · Fax +33 388 730118
e-Mail sales@comtec-crystals.com
Internet: <http://www.comtec-crystals.com>
Sous réserve de modifications.