

High Frequency Tolerance
Crystal Clock Oscillator CXO7050TR2.5 2.5V

- SMD in ceramic case (7.0 x 5.0 x 1.8) mm
- Tri-State Enable / Disable
- LVCMOS Square Wave
- on Tape & Reel (Tape 16mm)
- RoHS conform; Lead-free product
- Vibration: MIL-STD-202F method 204, 35G, 50 to 2000 Hz
- Shock: MIL-STD-202F method 213B, test cond. E, 1000GG 1/2 sine wave
- Available in many standard and special frequencies

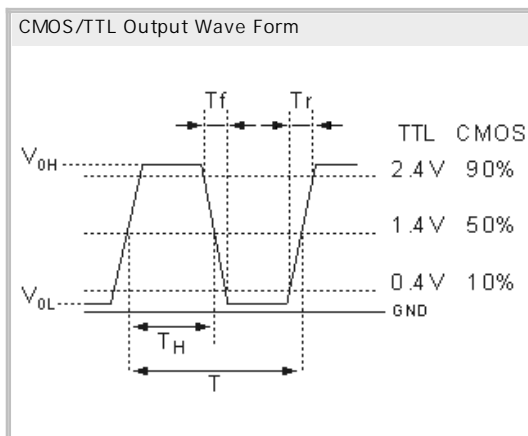
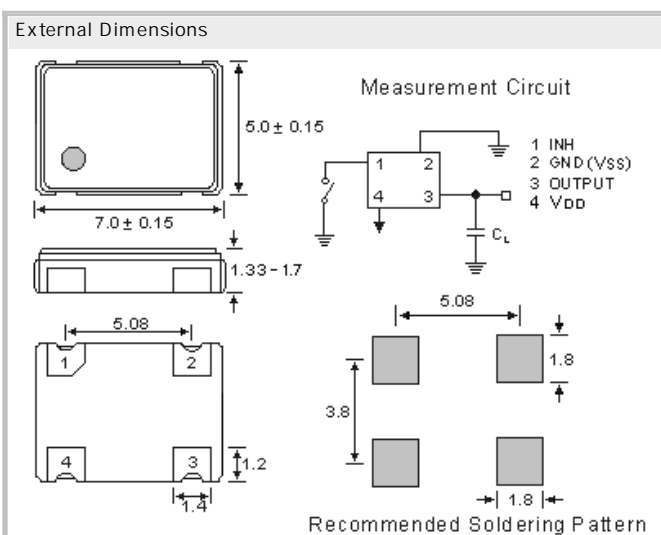

Specifications

Holder Type:	High Frequency Tolerance CXO7050TR2.5 Tri-State 2.5V (Voltage code is " 2.5 ")
Frequency:	40.000000 MHz
Frequency Tolerance at 25°C:	± 2.0 ppm (max.)
Frequency Stability:	± 15.0 ppm
Operating Temperature Range:	-40°C to +85°C
Storage Temperature:	-55°C to +150°C
Power Supply Voltage (Vdd):	+ 2.5V D.C. ± 5%
Maximum Supply Current:	5.00mA max.
Output Load:	15pF
Output Symmetry (Duty Cycle):	50% ± 5% (measured at 50% Vdd)
Output Logic Levels:	High "1" Vdd-0.4(min) // Low "0" 0.1V (typical), 0.4V (max.)
Rise/Fall Time (10% to 90% Vdd):	2 ns (typical) < 4 ns max.
Tri-state Function on Pin 1:	Pin 1 = H or open... Output active at pin 3 Pin 1 = L... high impedance at pin 3
Phase Jitter (RMS) [25MHz, 3.3V]:	300fs (typical) [12kHz to 20MHz integrated]
SSB Phase Noise [25MHz, 3.3V]:	-65dBc/Hz @ 10Hz, -100dBc/Hz @ 100Hz, -130dBc/Hz @ 1kHz -145dBc/Hz @ 10kHz, -148dBc/Hz @ 100kHz, -152dBc/Hz @ 1MHz, -155dBc/Hz @ 10MHz
Aging:	< ±2ppm max. / for the first year
Reflow Condition:	260°C max for 10 sec.

GERMANY:

COMTEC CRYSTALS GmbH · Sultenstrasse 12-14
8 5 5 8 6 P o i n g / G E R M A N Y
Phone +49 8121 778160 · Fax +49 8121 778177
e-Mail info@comtec-crystals.com
Internet: <http://www.comtec-crystals.com>
Subject to change without prior notice.



Technical Data and Graphics are all under
Copyright (c) of Comtec Crystals Group.

FRANCE:

COMTEC CRYSTALS SARL · 23, rue du Faucon
6 7 5 0 0 H a g u e n a u / F R A N C E
Phone +33 388 732162 · Fax +33 388 730118
e-Mail sales@comtec-crystals.com
Internet: <http://www.comtec-crystals.com>
Sous réserve de modifications.