

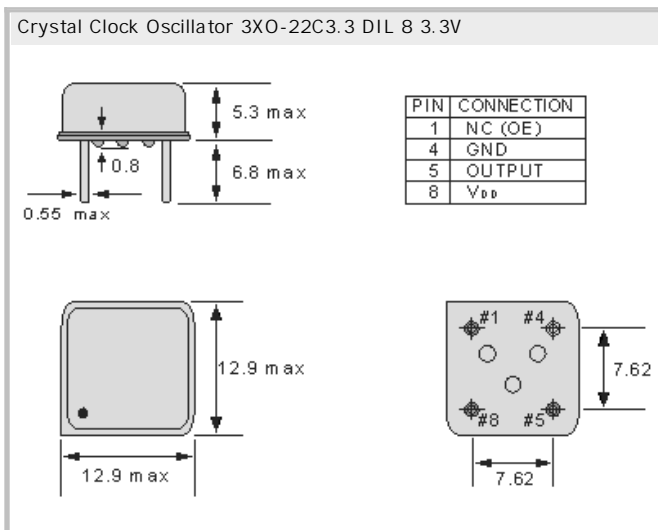

Crystal Clock Oscillator 3XO-22C3.3 DIL 8 3.3V

- micro-processor clocks
- ultra compact metal package
- CMOS/TTL Square Wave
- Available in many standard and special frequencies
- packed in antistatic tubes
- RoHS conform; Lead-free product



## Specifications

Holder Type:	Crystal Clock Oscillator 3XO-22C3.3 DIL 8 3.3V
Frequency:	100.000000 MHz
Frequency Stability at 25°C:	± 50.0 ppm
Operating Temperature Range:	± 50.0 ppm over -40°C to +85°C (inclusive of 25°C tolerance, ±10% input voltage variation, load change, aging, shock and vibration)
Storage Temperature:	-50°C to +100°C
Power Supply Voltage (V <sub>DD</sub> ):	+ 3.3V D.C. ± 10%
Maximum Supply Current:	45.0 mA max.
Output Load CL:	2 - 10 (LS) TTL gates, 15 pF HCMOS
Output Symmetry (Duty Cycle):	40/60%
Output Voltage (V <sub>OH</sub> ) (V <sub>OL</sub> ):	90% of V <sub>DD</sub> min. / 10% of V <sub>DD</sub> max.
Rise/Fall Time (10% to 90% V <sub>DD</sub> ):	10 ns max. < 5 ns typical
Start Up Time:	10 ms max. < 5 ms typical
Aging:	< ± 5ppm max. / year (max.)
Moisture sensitivity level:	MSL=1 per IPC/JEDEC J-STD-020 C

### GERMANY:

COMTEC CRYSTALS GmbH · Sultenstrasse 12-14  
 8 5 5 8 6 P o i n g / G E R M A N Y  
 Phone +49 8121 778160 · Fax +49 8121 778177  
 e-Mail [info@comtec-crystals.com](mailto:info@comtec-crystals.com)  
 Internet: <http://www.comtec-crystals.com>  
 Subject to change without prior notice.



Technical Data and Graphics are all under  
 Copyright (c) of Comtec Crystals Group.

### FRANCE:

COMTEC CRYSTALS SARL · 23, rue du Faucon  
 6 7 5 0 0 H a g u e n a u / F R A N C E  
 Phone +33 388 732162 · Fax +33 388 730118  
 e-Mail [sales@comtec-crystals.com](mailto:sales@comtec-crystals.com)  
 Internet: <http://www.comtec-crystals.com>  
 sous réserve de modifications.