

## Quartz Crystal Unit UM1

- Standard Quartz Crystal
- Available with Radial Taping Package (from 1 k)
- Available in many standard and special frequencies
- RoHS conform; Lead-free product

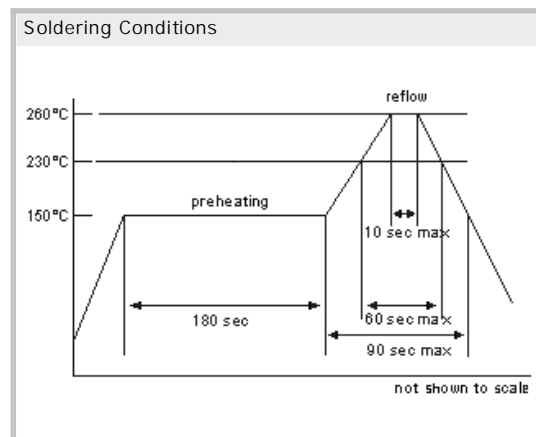
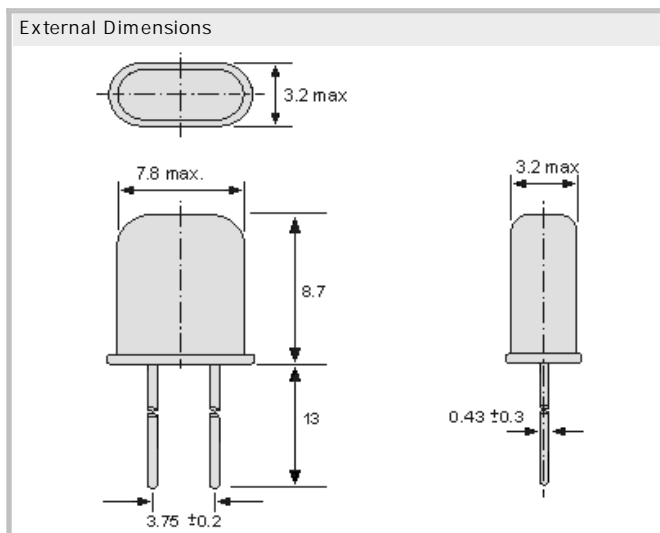

## Specifications - Product No. A035393600AF3SPS4DGG

Holder Type:	UM1
Frequency:	35.393600 MHz
Frequency Stability at 25°C:	± 10 ppm
Temperature Stability:	± 10 ppm @ -40°C to +65°C
Storage Temperature:	-50°C to +105°C
Drive Level:	100µW (500µW max.)
Load Capacitance (CL):	series (00)
Shunt Capacitance (CO):	< 7pF
Crystal Cut & Vibration Mode:	AT - cut, 3rd overtone
Equivalent Series Resistance:	80 Ohm max.
Leak:	2 x 10 <sup>-8</sup> cc/sec max. helium
Aging:	< ± 3ppm max. / year (max.)

### GERMANY:

COMTEC CRYSTALS GmbH · Sultenstrasse 12-14  
 8 5 5 8 6 P o i n g / G E R M A N Y  
 Phone +49 8121 778160 · Fax +49 8121 778177  
 e-Mail [info@comtec-crystals.com](mailto:info@comtec-crystals.com)  
 Internet: <http://www.comtec-crystals.com>  
 Subject to change without prior notice.



Technical Data and Graphics are all under  
 Copyright (c) of Comtec Crystals Group.

### FRANCE:

COMTEC CRYSTALS SARL · 23, rue du Faucon  
 6 7 5 0 0 H a g u e n a u / F R A N C E  
 Phone +33 388 732162 · Fax +33 388 730118  
 e-Mail [sales@comtec-crystals.com](mailto:sales@comtec-crystals.com)  
 Internet: <http://www.comtec-crystals.com>  
 Sous réserve de modifications.