

Differential LVDS Clock Oscillator
CXO5032DK3.3, 3.3V, 0,2 psec Jitter, non PLL

- SMD in ceramic case (5.0 x 3.2 x 1.2) mm
- Tri-State Enable / Disable on pad No. 1
- Femto second integrated phase jitter (300 fs typical, 12 KHz to 20 MHz)
- Superior phase noise (-138 dBc/Hz at 10 KHz and -142 dBc/Hz at 100 KHz offset)
- RoHS conform; Lead-free product; on Tape (16mm) & Reel
- Vibration: MIL-STD-202F method 204, 35G, 50 to 2000 Hz
- Shock: MIL-STD-202F method 213B, test cond. E, 1000GG 1/2 sine wave
- High performance with surprisingly low price

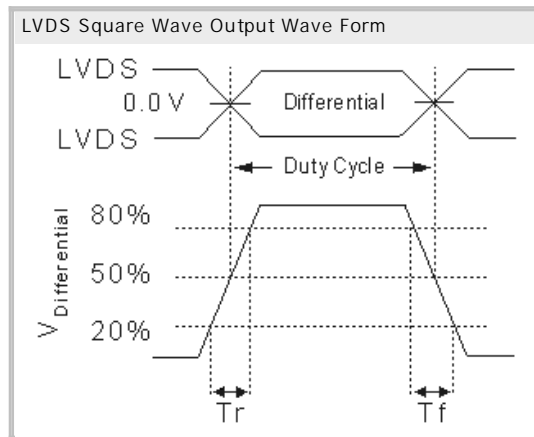
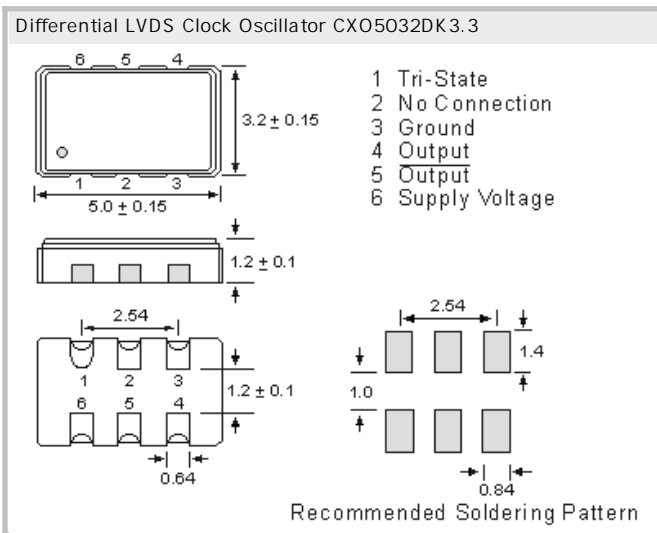

Specifications - Product No. G161130000QESUPN43AB

Holder Type:	CXO5032DK3.3; 3.3V(Voltage code is "3.3"); Tri-State on pad 1
Frequency:	161.130000 MHz
Frequency Stability at 25°C:	± 25.0 ppm
Operating Temperature Range:	± 25.0 ppm over -40°C to +85°C (inclusive of 25°C tolerance, ±10% input voltage variation, load change, aging, shock and vibration)
Storage Temperature:	-55°C to +150°C
Power Supply Voltage (Vdd):	+ 3.3V D.C. ± 5%
Maximum Supply Current (15pF load):	16.0 mA typ.
Output Voltage Swing:	250 mV min; 350 mV typical; 450 mV max. RL= 1000ohm
Output Logic Levels:	High "1" 1.43V typical; 1.6V max, RL= 100 ohms.; Low "0" 0.9V min; 1.1V typical, RL= 100 ohms
Output Symmetry (Duty Cycle):	50% ± 5% max. measured at 50% waveform
Load:	RL= 100 ohms between output and complimentary output
Rise/Fall Time:	Tr = 0.2 ns. typ; 0.4 ns. max. 20% -> 80% of waveform Tf = 0.2 ns. typ; 0.4 ns. max. 80% -> 20% of waveform
Start Up Time:	± 3 ppm max. first year ; ± 2 ppm max. per year thereafter
Tri-state Function Pin 1:	Enable II When 70% min. of VDD to Enable Output. Enable time : 10 ms max. Disable II When 30% max. of VDD to Disable Output. Disable current : 10 µA max. , Disable time : 0.2 µs max.
Phase Jitter (12 kHz to 20 MHz):	0.2 ps typical, 0.5 ps (max.), for 156.250 MHz, 3.3V
Phase Noise (156.250 MHz):	-50dBc/Hz @ 10Hz, -80dBc/Hz @ 100Hz, -115dBc/Hz @ 1kHz -135dBc/Hz @ 10kHz, -142dBc/Hz @ 100kHz, -147dBc/Hz @ 1MHz, -152dBc/Hz @ 10MHz
Aging:	< ± 3ppm max. for the first year
Reflow Condition:	260°C max for 10 sec.

GERMANY:

COMTEC CRYSTALS GmbH · Sultenstrasse 12-14
8 5 5 8 6 P o i n g / G E R M A N Y
Phone +49 8121 778160 · Fax +49 8121 778177
e-Mail info@comtec-crystals.com
Internet: <http://www.comtec-crystals.com>
Subject to change without prior notice.



Technical Data and Graphics are all under
Copyright (c) of Comtec Crystals Group.

FRANCE:

COMTEC CRYSTALS SARL · 23, rue du Faucon
6 7 5 0 0 H a g u e n a u / F R A N C E
Phone +33 388 732162 · Fax +33 388 730118
e-Mail sales@comtec-crystals.com
Internet: <http://www.comtec-crystals.com>
sous réserve de modifications.